

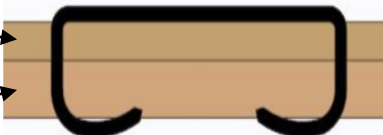

## Configuration Stapling-/Nailing-Machine





Company:		Phone:	
Street:		Fax:	
Postal Code/Location:		E-Mail:	
Country:			
Contact:		Department:	

**Please complete the questionnaire. Not all fields have to be completed.**



**A) Category**

<input type="checkbox"/> Stapling Material 1 →  Material 2 →	<input type="checkbox"/> Nailing Material 1 →  Material 2 →
--	---

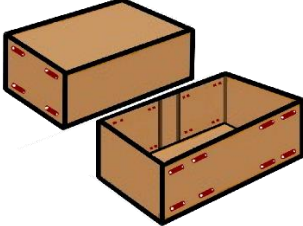

**B) Material**

Material 1:	<input type="checkbox"/> carton	<input type="checkbox"/> plastic	<input type="checkbox"/> wood	<input type="checkbox"/> others:
Material 2:	<input type="checkbox"/> carton	<input type="checkbox"/> plastic	<input type="checkbox"/> wood	<input type="checkbox"/> others:
<input type="checkbox"/> Solid board			If known, indicate strength or FEFCO No.	
<input type="checkbox"/> Single corrugated board				
<input type="checkbox"/> Double corrugated board				
<input type="checkbox"/> Triple corrugated board				
<input type="checkbox"/> Material thickness:	Material 1 (mm):		Material 2 (mm):	
<input type="checkbox"/> Material layers:	<input type="checkbox"/> single	<input type="checkbox"/> double	<input type="checkbox"/> triple	<input type="checkbox"/> -fold
<input type="checkbox"/> Staple position/s Sketch with indication of staple position/s; for each size one sketch under point P). (Please send pictures and samples!)				

**C) Version**

<input type="checkbox"/> Folding boxes 	<input type="checkbox"/> Telescope cartons 	<input type="checkbox"/> Cardboard trays 
<input type="checkbox"/> Other cardboard boxes (please define exactly under P) or/and insert pictures)	<input type="checkbox"/> Other articles (please define exactly under P) or/and insert pictures)	

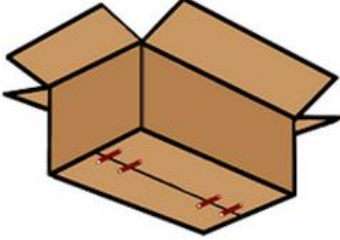
**D) Type of Closure**

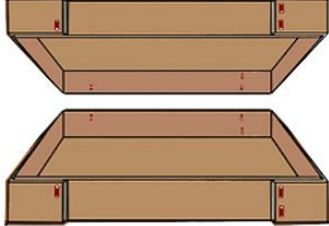
<input type="checkbox"/> Bottom closure 	<input type="checkbox"/> Top closure 	<input type="checkbox"/> Bottom/top tray 
<input type="checkbox"/> Other articles (please define exactly under P) or/and insert pictures)		

**E) Carton with content**

Weight:	kg
Content:	

**F) Sizes**

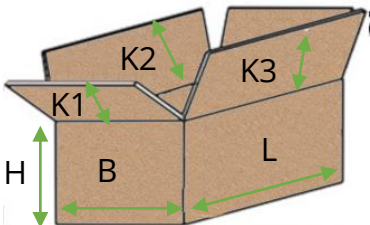
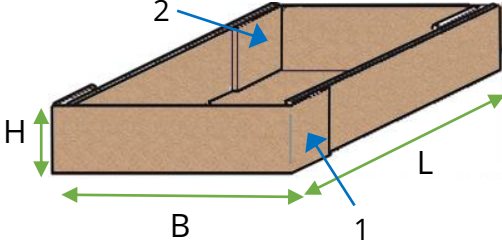
<input type="checkbox"/> <b>Carton</b> 	<input type="checkbox"/> <b>Tray</b> Flap folding: 1) <input type="checkbox"/> outside      2) <input type="checkbox"/> inside 	<input type="checkbox"/> <b>Others</b> (please specify under P) <div style="text-align: center; font-size: 2em;">?</div>
---	--	--

Part designation	Carton/tray			Carton/top/bottom		
	L in mm	B in mm	H in mm	K1 in mm	K2 in mm	K3 in mm

**G) Workflow**

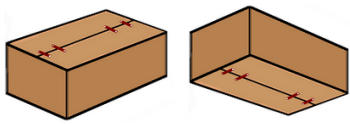
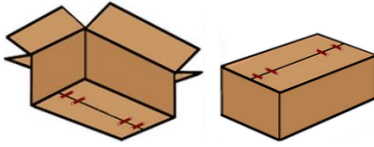
Process			Comment
<input type="checkbox"/> Unfold cardboard	<input type="checkbox"/> manual	<input type="checkbox"/> automatic	
<input type="checkbox"/> Fold carton bottom	<input type="checkbox"/> manual	<input type="checkbox"/> automatic	
<input type="checkbox"/> Filling the carton	<input type="checkbox"/> manual	<input type="checkbox"/> automatic	
<input type="checkbox"/> Fold carton lid	<input type="checkbox"/> manual	<input type="checkbox"/> automatic	
<input type="checkbox"/> simultaneous bottom and lid closure of the filled folding box  	<input type="checkbox"/> first close the bottom of the empty folding box, then fill the folding box then close the lid of the filled folding box  	<input type="checkbox"/> Define other sequence under P)	

**H) Staple material/size**

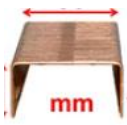
Material:	<input type="checkbox"/> Steel, copper plated	<input type="checkbox"/> Steel, galvanised	<input type="checkbox"/> Stainless steel	<input type="checkbox"/> other:		
Crown size:		<input type="checkbox"/> 9 mm For stapling and nailing	<input type="checkbox"/> 13 mm For stapling and nailing	<input type="checkbox"/> 20 mm For stapling and nailing	<input type="checkbox"/> 36 mm For stapling	<input type="checkbox"/> other:

**I) Number of staples**

pcs. per	<input type="checkbox"/> Bottom	<input type="checkbox"/> Top	<input type="checkbox"/> Flap	<input type="checkbox"/> Side	<input type="checkbox"/> other:
----------	---------------------------------	------------------------------	-------------------------------	-------------------------------	---------------------------------

**J) Working capacity/cycle number**

Quantity:	pcs.	<input type="checkbox"/> minute	<input type="checkbox"/> hour	<input type="checkbox"/> other:
-----------	------	---------------------------------	-------------------------------	---------------------------------

**K) Design**

<input type="checkbox"/> mobile	<input type="checkbox"/> fix location
<input type="checkbox"/> free-standing	<input type="checkbox"/> integrate into existing line (please specify)

**L) Degree of automation**

<input type="checkbox"/> mechanical version (manual)
<input type="checkbox"/> Semi-automatic (manual insertion/removal) (pneumatic or electro-pneumatic version)
<input type="checkbox"/> Fully automatic operation (electro-pneumatic version)

**M) Adjustment to other sizes**

Article sizes come	<input type="checkbox"/> chaotically (different sizes one after the other)	<input type="checkbox"/> in series pieces (same size one after the other)
--------------------	---	--

Stapling machine should be adjusted to the different sizes:					
<input type="checkbox"/> manuell	x per	<input type="checkbox"/> shift	<input type="checkbox"/> day	<input type="checkbox"/> other:	
<input type="checkbox"/> automatic					

**N) Requested delivery date**

Calendar week/year:	
---------------------	--

**O) Special internal company rules (specifications)**

<input type="checkbox"/> none	<input type="checkbox"/> yes, please send documents
-------------------------------	---



